

# Data sheet Controller N1200

## Universal Controller – Instructions manual – V2.0x



### SAFETY ALERTS

The symbols below are used on the equipment and throughout this document to draw the user's attention to important operational and safety information.

<b>CAUTION:</b> Read the manual thoroughly before installing and operating the equipment.	<b>CAUTION OR DANGER:</b> Electrical Shock Hazard

All safety related instructions that appear in the manual must be observed to ensure personal safety and to prevent damage to either the instrument or the system. *If the instrument is used in a manner not specified by the manufacturer, the protection provided by the equipment may be impaired.*

### INTRODUCTION

The N1200 is an extraordinarily versatile process controller. It holds in one single instrument all the main features needed for the vast majority of industrial processes. It accepts in a single model virtually all the sensors and signals used in the industry and provides the main output types required for the operation of diverse processes.

The configuration can be performed directly on the controller or through the USB interface. The **NConfig** software (free) is the configuration management tool. Connected to the USB of a Windows computer, the controller is recognized as a serial communications port (COM) running with a Modbus RTU protocol.

Through the USB interface, even if disconnected from the power supply, the configuration performed in a piece of equipment can be saved in a file and repeated in other pieces of equipment that require the same configuration.

It is important that the users read carefully this manual before using the controller. Verify if the release of this manual matches the instrument version (the firmware version is shown when the controller is energized). The N1200 main characteristics are:

- Multi-sensor universal input;
- Protection for open sensor in any condition;
- Relay, 4-20 mA and logic pulse control outputs all available in the standard model;
- Self-tuning of PID parameters;
- Automatic / Manual function with "bumpless" transfer;
- Four modes of independent alarms, with functions of minimum, maximum, differential (deviation), open sensor and event;
- Timer functions that can be associated to the alarms;
- Retransmission of PV or SP in 0-20 mA or 4-20 mA;
- Input for remote *setpoint*;
- Digital input with 5 functions;
- Programmable *soft-start*;
- 20 setpoint profile programs with 9 segments each, with the ability to be linked together for a total of 180 segments;
- Password for parameters protection;
- Universal power supply.

### CONFIGURATION / FEATURES

#### INPUT TYPE SELECTION

Select the input type (in parameter "**TYPE**") from **Table 1** below.

TYPE	CODE	RANGE OF MEASUREMENT
J	<b>tc J</b>	Range: -110 to 950 °C (-166 to 1742 °F)
K	<b>tc k</b>	Range: -150 to 1370 °C (-238 to 2498 °F)
T	<b>tc t</b>	Range: -160 to 400 °C (-256 to 752 °F)
N	<b>tc n</b>	Range: -270 to 1300 °C (-454 to 2372 °F)
R	<b>tc r</b>	Range: -50 to 1760 °C (-58 to 3200 °F)
S	<b>tc S</b>	Range: -50 to 1760 °C (-58 to 3200 °F)
B	<b>tc b</b>	Range: 400 to 1800 °C (752 to 3272 °F)
E	<b>tc E</b>	Range: -90 to 730 °C (-130 to 1346 °F)
Pt100	<b>Pt</b>	Range: -200 to 850 °C (-328 to 1562 °F)
0-20 mA	<b>LQ20</b>	Linear Signals Programmable indication from -1999 to 9999.
4-20 mA	<b>L420</b>	
0-50 mV	<b>LQ50</b>	
0-5 Vdc	<b>LQ5</b>	
0-10 Vdc	<b>LQ10</b>	
4-20 mA NON LINEAR	<b>Ln J</b>	Non Linear Analog Signals Indication range depends on the selected sensor
	<b>Ln k</b>	
	<b>Ln t</b>	
	<b>Ln n</b>	
	<b>Ln r</b>	
	<b>Ln S</b>	
	<b>Ln b</b>	
<b>Ln E</b>		
	<b>LnPt</b>	

Table 1 - Input types

**Note:** All input types are factory calibrated.

#### CONFIGURATION OF OUTPUTS, ALARMS AND DIGITAL INPUTS

The controller input and output channels (I / O) can assume multiple functions: control output, digital input, digital output, alarm output, retransmission of PV and SP. These channels are identified as I / O 1, I / O 2, I / O 3, I / O 4 and I / O 5.

The basic controller model comes loaded with the following features:

- I / O 1- output to Relay SPST-NA;
- I / O 2- output to Relay SPST-NA;
- I / O 5- current output, digital output, digital input;

**Optionally**, other features can be added, as shown under the item "Identification" in this manual:

- **3R:** I / O3 with output to SPDT relay;
- **DIO:** I / O3 and I / O4 as digital input and output channels;
- **HBD:** Heater break detect;
- **485:** Serial Communication;

The function to be used in each channel of I/O is defined by the user in accordance with the options shown in the **Table 2**.

FUNCTION OF I/O	CODE	TYPE OF I/O
Without Function	<b>oFF</b>	Output
Output of Alarm 1	<b>A1</b>	Output
Output of Alarm 2	<b>A2</b>	Output
Output of Alarm 3	<b>A3</b>	Output
Output of Alarm 4	<b>A4</b>	Output
LBD - Loop break detection	<b>Lbd</b>	Output
Control Output (Relay or Digital Pulse)	<b>ctrL</b>	Output
Automatic / Manual mode selection	<b>mAN</b>	Digital Input
Run / Stop mode selection	<b>run</b>	Digital Input
Remote SP selection	<b>rSP</b>	Digital Input
Setpoint profile program HOLD (Freezes program execution)	<b>HPrg</b>	Digital Input
Setpoint Profile Program 1 selection	<b>Pr 1</b>	Digital Input
0 to 20 mA control output selection	<b>C.020</b>	Analogical Output
4 to 20 mA control output selection	<b>C.420</b>	Analogical Output
Retransmission of PV in 0 to 20 mA	<b>P.020</b>	Analogical Output
Retransmission of PV in 4 to 20 mA	<b>P.420</b>	Analogical Output
Retransmission of Sp in 0 to 20 mA	<b>S.020</b>	Analogical Output
Retransmission of SP in 4 to 20 mA	<b>S.420</b>	Analogical Output

Table 2 - Types of functions for the I/O channels

During the configuration of the I/O channels, only the valid options for each channel will be shown on the display. These functions are described below:

- **oFF** - Without function

The I/O channel programmed with code **oFF** will not be used by the controller. Although without function, this channel is available through the serial communication as digital I/O (command 5 MODBUS).

- **A1, A2, A3, A4** – Alarm Outputs

The selected channel can be used as output to Alarms 1 to 4. Defines that the programmed I/O channel acts as alarm outputs. Available for all the I/O channels.

- **Lbd** – Loop Break Detector function.

Assigns the output of the Loop Break Detector alarm to an I/O channel. Available to all I/O channels.

- **ctrL** – PWM Control Output

Defines the I/O channel to be used as the PWM control output (relay or digital pulse). Available for all the I/O channels. The digital pulse is available on I/O5 (standard) or on I/O3 and I/O4 (when the DIO optional is installed). Check the specifications of each channel.

- **mAN** - Digital Input with Auto/Manual function

Defines the I/O channel as Digital Input with the function of switching the control mode between **Automatic and Manual**. Available on I/O5 (standard) or on I/O3 and I/O4 (when the DIO optional is installed).

**Closed** = Manual control;

**Open** = Automatic control

- **run** - Digital Input with RUN function

Defines channel as Digital Input with the function of enabling/disabling the control and alarm outputs ("**run**": YES / no). Available for I/O5 or I/O3 and I/O4, when installed.

**Closed** = outputs enabled

**Open** = control and alarms output shut off

- **rSP** - Digital Input with Remote SP function

Defines channel as Digital Input with the function of selecting the remote SP as the control setpoint. Available for I/O5 or I/O3 and I/O4, when available.

**Closed** = remote SP

**Open** = uses main SP

- **HPrg** - Digital Input with Hold Program function

Defines channel as Digital Input with the function of commanding the execution of the selected setpoint profile **program**. Available for I/O5 or I/O3 and I/O4, when available.

**Closed** = Enables execution of the program

**Open** = Interrupts (freezes) execution of the program

**Note:** Even when the execution of the program is interrupted, the control output remains active and controlling the process at the point (Setpoint) of interruption. The program will resume its normal execution starting from this same point when the digital input is closed.

- **Pr 1** - Digital Input with function to Execute Program 1

Defines the IO channel as Digital Input with the function of commanding the execution of the setpoint profile **program 1**. Available for I/O5 or I/O3 and I/O4, when available.

Useful function for switching between the main *setpoint* and a secondary one defined by the **program 1**.

**Closed** = selects program 1;

**Open** = selects main *setpoint*

- **C.020** – 0-20 mA Control Output

Available for I/O 5 only, defines the channel as a 0-20 mA control output.

- **C.420** - 4-20 mA Control Output

Defines the channel as a 4-20 mA control output.

- **P.020** – 0-20 mA PV retransmission

Available for I/O 5 only, configures the channel to retransmit the values of PV in 0-20 mA.

- **P.420** - 4-20 mA PV retransmission

Available for I/O 5 only, configures the channel to retransmit the values of PV in 4-20 mA.

- **S.020** 0-20 mA SP (Setpoint) retransmission

Available for I/O 5 only, configures the channel to retransmit the values of SP in 0-20 mA.

- **S.420** 4-20 mA SP (Setpoint) retransmission

Available for I/O 5 only, configures the channel to retransmit the values of SP in 0-20 mA.

## CONFIGURATION OF ALARMS

The controller has 4 independent alarms. These alarms can be configured to operate with nine different functions, as shown in Table 3.

- **oFF** – Alarms turned **oFF**.

- **IErr** – Open Sensor alarms - (*Loop Break*)

The open sensor alarm acts whenever the input sensor is broken or badly connected.

- **rS** – Program Event Alarm

Configures the alarm to act in (a) specific segment(s) of the programs of ramps and baselines to be created by the user.

- **Rfai1** – Burnt-out Resistance Alarm - (*Heat Break*)

Signals that the heating element has broken up. This alarm function requires the accessory Current transformer CT1. Details for use of the option "burnt-out resistance" are found in the specific documentation that accompanies the product whenever this option is requested.

- **Lo** – Alarm of Absolute Minimum Value

Triggers when the value of measured PV is **below** the value defined for alarm Setpoint.

- **Hi** – alarm of Absolute Maximum Value

Triggers when the value of measured PV is **above** the value defined for alarm *Setpoint*.

- **dIF** – Alarm of Differential Value

In this function the parameters "**SPA1**", "**SPA2**", "**SPA3**" and "**SPA4**" represent the Deviation of PV in relation to the SP.

Using the Alarm 1 as example: for Positive SPA1 values, the Differential alarm triggers when the value of PV is **out** of the range defined for:

$$(SP - SPA1) \text{ to } (SP + SPA1)$$

For a negative SPA1 value, the Differential alarm triggers when the value of PV is **within** the range defined above:

- **dIFL** – Alarm of Minimum Differential Value

It triggers when the value of PV is below the defined point by:

$$(SP - SPA1)$$

Using the Alarm 1 as example.

- **dIFH** – Alarm of Maximum Differential Value

Triggers when the value of PV is **above** the defined point by:

$$(SP + SPA1)$$

Using the Alarm 1 as example.

SCREEN	TYPE	ACTUATION
<b>oFF</b>	Inoperative	Output is not used as alarm.
<b>IErr</b>	Open sensor (input Error)	Activated when the input signal of PV is interrupted, out of the range limits or Pt100 in short-circuit.
<b>rS</b>	Event (ramp and Soak)	Activated in a specific segment of program.
<b>rFR IL</b>	Resist. burnt out (resistance fail)	Signals a failure in the heating element.
<b>Lo</b>	Minimum value (Low)	
<b>Hi</b>	Maximum value (High)	
<b>dIF</b>	Differential (diFerential)	
<b>dIFL</b>	Minimum Differential (diFerential Low)	
<b>dIFH</b>	Maximum differential (diFerential High)	

Table 3 – Alarm Functions

Where SPAn refers to Setpoints of Alarm “SPA1”, “SPA2”, “SPA3” and “SPA4”.

**ALARM TIMER MODES**

The controller alarms can be configured to perform 3 timer modes:

- One pulse with defined duration;
- Delayed activation;
- Repetitive pulses;

The illustrations in Table 4 show the behavior of the alarm output for various combinations of times t1 and t2. The timer functions can be configured in parameters **A1E1**, **A1E2**, **A2E1**, **A2E2**, **A3E1**, **A3E2**, **A4E1** and **A4E2**.

OPERATION	T 1	T 2	ACTION
Normal Operation	0	0	
Activation for a defined time	1 to 6500 s	0	
Activation with delay	0	1 to 6500 s	
Intermittent Activation	1 to 6500 s	1 to 6500 s	

Table 4 – Temporization Functions for the Alarms

The LEDs associated to the alarms will light when the alarm condition is recognized, not following the actual state of the output, which may be temporarily OFF because of the temporization.

**INITIAL BLOCKING OF ALARM**

The initial blocking option inhibits the alarm from being recognized if an alarm condition is present when the controller is first energized (or after a transition from run YES →NO). The alarm will be enabled only after the occurrence of a non-alarm condition followed by a new occurrence for the alarm.

The initial blocking is useful, for instance, when one of the alarms is configured as a minimum value alarm, causing the activation of the alarm soon upon the process start-up, an occurrence that may be undesirable.

The initial blocking is disabled for the sensor break alarm function.

**EXTRACTION OF THE SQUARE ROOT**

With this feature enabled the controller uses for display and control a value that corresponds to the square root of the applied input signal.

Available only for the inputs belonging to the group of linear analogic signals: 0-20 mA, 4-20 mA, 0-50 mV, 0-5 V and 0-10 V.

**ANALOG RETRANSMISSION OF PV AND SP**

The analog output, when not used for control purposes, is available for retransmitting the PV and SP values in 0-20 or 4-20 mA. This analog output is electrically isolated from other inputs and outputs.

The analog output signal is scalable, with the output range defined by the values programmed in the parameters “rELL” and “rEHL”.

To obtain a voltage output, the user must install a resistor shunt (550 Ω max.) to the current output terminals (terminals 7 and 8). The actual resistor value depends on the desired output voltage span.

**SOFT-START**

The soft-start feature avoids abrupt variations in the power delivered to the load regardless of the system power demand.

This is accomplished by defining a limiting ramp for the control output. The output is allowed to reach maximum value (100 %) only after the time programmed in the soft-start parameter has elapsed. The Soft-start function is generally used in processes that require slow start-up, where the instantaneous application of 100 % of the available power to the load may cause damages to parts of the system.

In order to disable this function, the soft-start parameter must be configured with 0 (zero).

**REMOTE SETPOINT**

The controller can have its Setpoint value defined by an analog, remotely generated signal. This feature is enabled through the channels I/O3, I/O4 or I/O5 when configured as digital inputs and configured with the function **rSP** (Remote SP selection) or through the parameter **ErSP**. The remote setpoint input accepts the signals 0-20 mA, 4-20 mA, 0-5 V and 0-10 V.

For the signals of 0-20 and 4-20 mA, a shunt resistor of **100 Ω** is required between terminals 9 and 10, as shown in **Figure 4c**.

**CONTROL MODE**

The controller can operate in two different manners: Automatic mode or Manual mode. In automatic mode the controller defines the amount of power to be applied on the process, based on defined parameters (SP, PID, etc.).

In the manual mode the user himself defines this amount of power. The parameter “**Ctrl**” defines the control mode to be adopted.

**PID AUTOMATIC MODE**

For the Automatic mode, there are two different strategies of control: PID control and ON/OFF control.

PID control has its action based on a control algorithm that takes into account the deviation of PV with respect to SP, the rate of change of PV and the steady state error.

On the other hand, the ON/OFF control (obtained when Pb=0) operates with 0 % or 100 % of power, when PV deviates from SP.

The determination of the PID parameters (Pb, Ir and Dt) is described in the item DETERMINATION OF PID PARAMETERS of this manual.

### LDB - LOOP BREAK DETECTION ALARM

The parameter defines a time interval, in minutes, within which the PV is expected to react to a control output signal. If the PV does not react properly within the time interval configured in **Ibd.t**, the controller interprets this as a control loop break and signals this occurrence in the display.

A LDB event may be sent to any I/O channel. Simply configure the LDB function to the desired I/O channel: the selected output will be activated when a LDB condition is detected. When the **Ibd.t** parameter is programmed with 0 (zero), the LDB function is disabled.

The LDB is useful in system supervision and troubleshooting, allowing early detection of problems in the actuator, power source or load.

### HBD - HEATER BREAK DETECTION

Available in the products identified with the suffix HBD. Visit our web site for further information [www.novusautomation.com](http://www.novusautomation.com).

### SAFE OUTPUT VALUE WITH SENSOR FAILURE

This function defines an output value (user defined) to be assigned to the control output in the event of a sensor failure.

When the input sensor is identified as broken, the controller forcing MV to assume the user configured value in the **1E.ov** parameter.

When the parameter **1E.ov** is configured with 0.0 (zero) value, this function is disabled and the control output is simply turned off upon input sensor error.



### USB INTERFACE

The USB interface is used for CONFIGURING or MONITORING the controller. The **NConfig** software must be used for the configuration. It makes it possible to create, view, save and open configurations from the equipment or files in your computer. The tool for saving and opening configurations in files makes it possible to transfer configurations between pieces of equipment and to make backup copies. For specific models, the **NConfig** software also makes it possible to update the firmware (internal software) of the controller through the USB.

For MONITORING purposes you can use any supervisory software (SCADA) or laboratory software that supports the MODBUS RTU communication on a serial communications port. When connected to the USB of a computer, the controller is recognized as a conventional serial port (COM x). Use the **NConfig** software or consult the DEVICE MANAGER in the Windows CONTROL PANEL to identify the COM port that was assigned to the controller. Consult the mapping of the MODBUS memory in the controller's communications manual and the documentation of your supervisory software to conduct the MONITORING process.

Follow the procedure below to use the USB communication of the equipment:

- Download the **NConfig** software from our website and install it on your computer. The USB drivers necessary for operating the communication will be installed together with the software.
- Connect the USB cable between the equipment and the computer. The controller does not have to be connected to a power supply. The USB will provide enough power to operate the communication (other equipment functions cannot operate).
- Open the **NConfig** software, configure the communication and start recognition of the device.
- Consult the **NConfig** help desk for detailed instructions about how to use it and solve problems.

 	<p>The USB interface IS NOT SEPARATE from the signal input (PV) or the controller's/indicator's digital inputs and outputs. It is intended for temporary use during CONFIGURATION and MONITORING periods. For the safety of people and equipment, it must only be used when the piece of equipment is completely disconnected from the input/output signals. Using the USB in any other type of connection is possible but requires a careful analysis by the person responsible for installing it. When MONITORING for long periods of time and with connected inputs and outputs, we recommend using the RS485 interface, which is available or optional in most of our products.</p>
--	---

## INSTALLATION / CONNECTIONS

The controller must be fastened on a panel, following the sequence of steps described below:

- Prepare a panel cut-out of 45.5 x 45.5 mm;
- Remove the mounting clamps from the controller;
- Insert the controller into the panel cut-out;
- Slide the mounting clamp from the rear to a firm grip at the panel.

### RECOMMENDATIONS FOR THE INSTALLATION

- All electrical connections are made to the screw terminals at the rear of the controller. They accept wire sizes from 0.5 to 1.5 mm<sup>2</sup> (16 to 22 AWG). The terminals should be tightened to a torque of 0.4 Nm (3.5 lb in)
- To minimize the pick-up of electrical noise, the low voltage DC connections and the sensor input wiring should be routed away from high-current power conductors. If this is impractical, use shielded cables. In general, keep cable lengths to a minimum.
- All electronic instruments must be powered by a clean mains supply, proper for instrumentation.
- It is strongly recommended to apply RC'S FILTERS (noise suppressor) to contactor coils, solenoids, etc.
- In any application it is essential to consider what can happen when any part of the system fails. The controller features by themselves can not assure total protection.

### ELECTRICAL CONNECTIONS

The controller's internal circuits can be removed without undoing the connections on the back panel.

The controller complete set of features is drawn in **Figure 1**. The features loaded in a particular unit are shown on its label

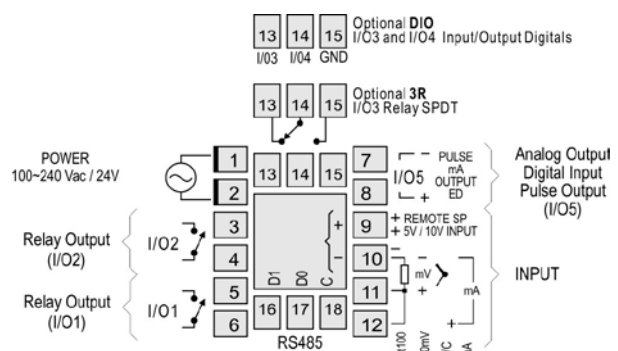

Figure 1 - Connections of the back panel

**Power Supply Connections**

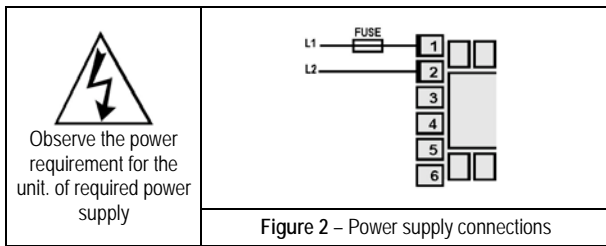

Figure 2 – Power supply connections

**Input Connections**

- Thermocouple (T/C) and 0-50 mV

The **Figure 3a** indicates the wiring for the thermocouple and 0-50mV signals. If the thermocouple wires needs to be extended, use appropriate compensation cables.

- RTD (Pt100):

**Figure 3b** shows the Pt100 wiring, for 3 conductors. For proper cable length compensation, use conductors of same gauge and length). For 4-wires Pt100, leave one conductor disconnected at the controller. For 2-wire Pt100, short-circuit terminals 11 and 12.

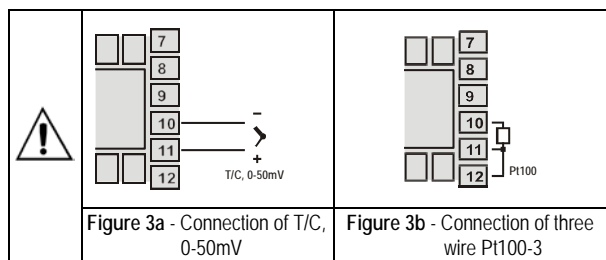

Figure 3a - Connection of T/C, 0-50mV

Figure 3b - Connection of three wire Pt100-3

- 4-20 mA:

The connections for current signals 4-20 mA must be carried-out according to **Figure 4a**.

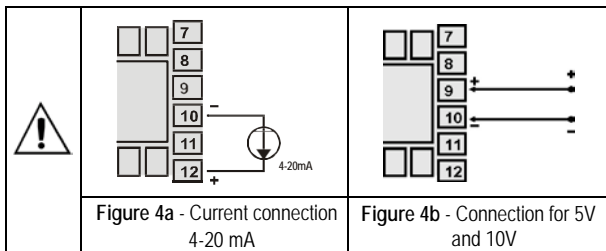

Figure 4a - Current connection 4-20 mA

Figure 4b - Connection for 5V and 10V

- 5 V and 10 V

Refer to **Figure 4b** for connecting voltage signals.

**Remote Setpoint**

Feature available in the controller's terminals 9 and 10. When the Remote SP input signal is 0-20 mA or 4-20 mA, an external **100Ω** shunt resistor of must be connected to terminals 9 and 10 as indicated in **Figure 4c**.

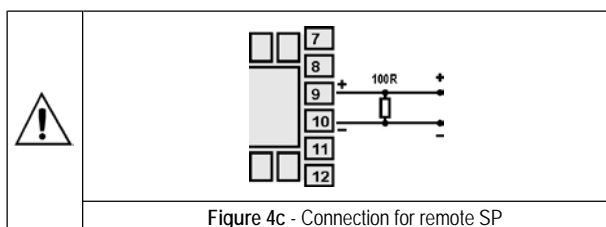

Figure 4c - Connection for remote SP

**Digital Input Connections**

**Figures 5a** and **5b** show switches driving I/O 3 and I/O 5. The same scheme applies to I/O 4

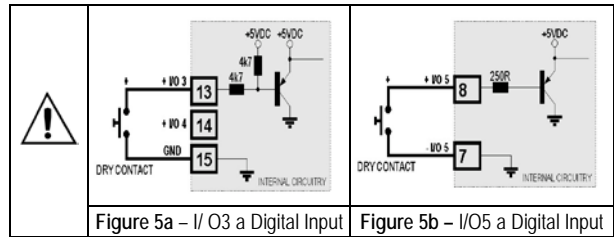

Figure 5a – I/O 3 a Digital Input

Figure 5b – I/O 5 a Digital Input

**Connection of Alarms and Outputs**

The I/O channels, when configured as outputs, must have their load limit capacities observed, according to the product specifications.

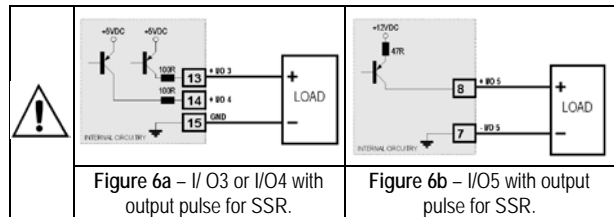

Figure 6a – I/O 3 or I/O 4 with output pulse for SSR.

Figure 6b – I/O 5 with output pulse for SSR.

I/O3, I/O4 and I/O5 can also be configured as digital outputs (I/O3 and I/O4 provide a 5 Vdc output signal whereas I/O5 a 12 Vdc signal). An example of usage is shown in **Figure 6a** for the I/O3 and in **Figure 6b** for the I/O5. I/O5 is electrically isolated from the sensor input

**OPERATION**

The controller's front panel, with its parts, can be seen in the **Figure 7**:

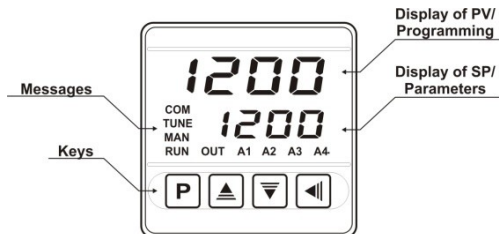

Figure 7 - Identification of the parts referring to the front panel

**Display of PV/Programming:** Displays the current value of PV (*Process Variable*). When in configuration mode, it shows the parameters names.

**Display of SP/Parameters:** Displays the value of SP (*Setpoint*). When in configuration mode, it shows the parameters values.

**COM indicator:** Flashes to indicate communication activity in the RS485 interface.

**TUNE indicator:** Stays ON while the controller is in tuning process.

**MAN indicator:** Signals that the controller is in the manual control mode.

**RUN indicator:** Indicates that the controller is active, with the control output and alarms enabled.

**OUT indicator:** For relay or pulse control output; it reflects the actual state of the output. If an analog output is assigned for control, the OUT indicator lights continuously.

**A1, A2, A3 and A4 indicators:** signalize the occurrence of alarm situation.

**[P] P Key (Program key):** used to walk through the menu parameters.

**[◀] Back Key:** used to retrocede parameters.

**[▲] Increment key and [▼] - Decrement key:** allow altering the values of the parameters.

When the controller is powered on, its firmware version is presented for 3 seconds, after which the controller starts normal operation. The values of PV and SP are displayed and the outputs are enabled.

In order to operate appropriately, the controller needs a configuration that is the definition of each one of the several parameters presented by the controller. The user must be aware of the importance of each parameter and for each one determine a valid condition or a valid value.

**Note:** Since many parameters depend on the input type chosen, it is recommended that the parameter **TYPE** be the first one to be configured.

The parameters are grouped in levels according to their functionality and operation easiness. The 7 levels of parameters are:

LEVEL	ACCESS
1 - Operation	Free access
2 - Tuning	Reserved access
3- R&S Programs	
4- Alarms	
5- Scale	
6- I/Os	
7- Calibration	

Table 5 – Cycles of Parameters

The parameters in the operation level have easy access through the key **[P]**. The access deeper levels use the combination of keys:

**[◀] (BACK) and [P] (PROG) pressed simultaneously**

Press **[P]** to advance or **[◀]** to retrocede parameters within a level. At the end of each level, the controller returns to the operation level. Keep pressing the **[P]** key to move fast forward in the level.

Alternatively, the controller returns to the operation level after pressing the **[◀]** key for 3 seconds

All configuration parameters are stored in protected memory. The values are saved when the keys **[P]** or **[◀]** are pressed after changing a parameter value. The value of SP is saved upon pressing the **[P]** key or every 25 seconds.

## DESCRIPTION OF THE PARAMETERS

### OPERATION CYCLE

To access the operation level parameters, press **[P]** until the desired parameter is displays.

PV Indication (Red Screen)	<b>PV and SP indication</b> – The upper display shows the current value of PV. The lower display shows the control SP value.
SP Indication (Green Screen)	
<b>Ctrl</b> Control	<b>Control Mode:</b> <b>Auto</b> - Means automatic control mode. <b>Man</b> – Means manual control mode. (bumpless transfer between automatic and manual control modes).
PV Indication (Red Screen)	MANIPULATED VARIABLE VALUE (MV): The upper display shows PV value and the lower display shows the <b>percentage</b> of MV applied to the control output. When in manual control, the MV value can be manually changed by the <b>[▲]</b> and <b>[▼]</b> keys. When in auto mode the MV value can only be viewed. To distinguish the MV display from the SP display, the MV is shown flashing intermittently.
MV Indication (Green Screen)	
<b>EP</b> Enable Program	<b>Execution of Program</b> - Selects the ramp and soak profile program to be executed. <b>0</b> - does not execute program <b>1 to 20</b> number of the program to be executed With enabled outputs (RUN = YES), the program starts right after the program is selected.

<b>PSEG</b>	Screen for indication only. When a ramp and soak program is active, this parameter shows the number of the segment under execution, from 1 to 9.
<b>tSEG</b>	Screen for indication only. When a ramp and soak program is in execution, it shows the remaining time to the end of the current segment, in units of time configured in the <b>PrLb</b> parameter.
<b>run</b>	Enables control outputs and alarms. <b>YES</b> - Outputs enables. <b>no</b> - Outputs not enabled.

### CYCLE OF TUNING

<b>Atun</b> Auto-tune	Defines the control strategy to be taken: <b>off</b> – Turned off. (no PID tuning) <b>FAST</b> – <b>FAST</b> automatic tuning. <b>FULL</b> – More accurate automatic tuning. <b>SELF</b> – Precise + auto - adaptative tuning <b>rSLF</b> – Forces <u>one</u> new precise automatic precise + auto - adaptative tuning. <b>t9Ht</b> - Forces <u>one</u> new precise automatic + auto - adaptative tuning when Run = YES or controller is turned on.
<b>Pb</b> Proportional Band	PROPORTIONAL BAND - Value of the term <b>P</b> of the control mode PID, in percentage of the maximum span of the input type. Adjust of between 0 and 500.0 %. Select zero for ON/OFF control.
<b>Ir</b> Integral Rate	INTEGRAL RATE - Value of the term <b>I</b> of the PID algorithm, in repetitions per minute (Reset). Adjustable between 0 and 99.99. Displayed only if proportional band ≠ 0.
<b>dt</b> Derivative Time	DERIVATIVE TIME - Value of the term <b>D</b> of the control mode PID, in seconds. Adjustable between 0 and 300.0 seconds. Displayed only if proportional band ≠ 0.
<b>Ct</b> Cycle Time	Pulse Width Modulation (PWM) period in seconds. Adjustable between 0.5 and 100.0 seconds. Displayed only if proportional band ≠ 0.
<b>HYSt</b> Hysteresis	CONTROL HYSTERESIS (in engineering. units): This parameter is only shown for ON / OFF control (Pb=0). Adjustable between 0 and the measurement input type span.
<b>Act</b> Action	CONTROL ACTION: For Auto Mode only. <b>rE</b> Control with reverse Action. Appropriate for <b>heating</b> . Turns control output on when PV is below SP. <b>dIr</b> Control with direct Action. Appropriate for <b>cooling</b> . Turns control output on when PV is above SP.
<b>Lbd</b> Loop break detection time.	Time interval for the LBD function. Defines the maximum interval of time for the PV to react to a control command. In minutes
<b>bIAS</b>	BIAS: Offset for MV (manual reset). Range: -100 % to +100 %. Allows adding a percentage value between -100 % and +100 % to the MV control output The value 0 (zero) disables the function.
<b>ouLL</b> Output Low Limit	Lower limit for the control output - Minimum percentage value assumed by the control output when in automatic mode and in PID. Typically configured with 0 %. Default value: 0 %

<b>oUHL</b> Output High Limit	Upper limit for the control output - Maximum percentage for the control output when in automatic mode and in PID. Typically configured with 100 %. Default value: 100 %
<b>SFSst</b> Softstart	SoftStart Function -: Time in seconds during which the controller limits the MV value progressively from 0 to 100 %. It is enabled at power up or when the control output is activated. If in doubt set zero (zero value disables the Soft start function).
<b>SPA 1</b> <b>SPA2</b> <b>SPA3</b> <b>SPA4</b>	ALARM SETPOINT: Tripping point for alarm 1, 2, 3 and 4. Value that defines the point of activation for the programmed alarms with the functions "Lo" or "Hi".  For the alarms configured with Differential type functions, this parameter defines deviation (band). Not used for the other alarm functions.

CYCLE OF PROGRAMS

<b>Pr.tb</b> Program time base	Defines the time base that will be used by all Ramp & Soak programs.  <b>SEC</b> - Time basis in seconds; <b>Min</b> - Time basis in minutes;
<b>Pr.n</b> Program number	Selects the ramp and soak profile program to be edited/viewed. The sequence of parameters that follows refer to this selected program. Total of 20 programs possible.
<b>Ptol</b> Program Tolerance	Maximum admitted deviation of PV with respect to SP. If exceeded, the program execution is suspended (the internal timer freezes) until the deviation be returns back within the defined tolerance.  The value 0 (zero) disables the function (the program progresses regardless of the difference between PV and SP).
<b>PSP0</b> <b>PSP9</b>	Program SP's, 0 to 9: Group of 10 values of SP that define the Ramp and Soak profile segments.
<b>Pt.1</b> <b>Pt.9</b>	Segments durations, 1 to 9: Defines the time of duration, in second or minutes, of the segments of the program being edited.
<b>PE.1</b> <b>PE.9</b> Program event	Alarms of Event, 1 to 9: Parameters that define which alarms are to be activated during the execution of a certain program segment. The alarms chosen must have its function configured as "rS." (See Table 3)
<b>LP</b> Link Program	Link Programs: Number of the next profile program to be linked following the current program. Profiles can be linked together to produce larger programs of up to 180 segments.  0 - do not link to any other program.

CYCLE OF ALARMS:

<b>FJA 1</b> <b>FJA2</b> <b>FJA3</b> <b>FJA4</b>	FUNCTIONS OF ALARMS 1 to 4. Defines the functions for the alarms among the options of the Table 3.
<b>bLA 1</b> <b>bLA2</b> <b>bLA3</b> <b>bLA4</b>	BLOCK ALARM 1 TO 4: This function blocks the alarms when the controller is energized.  <b>YES</b> - enables initial blocking <b>no</b> - inhibits initial blocking  When enabled, the alarm will not be active at power-up, waiting for PV (Process Variable) to reach a non-alarm situation. From this point on the alarm will be free to actuate should a new alarm situation occur.
<b>HYA 1</b>	ALARM HYSTERESIS: Defines the difference between the value of PV at which the alarm is

<b>HYA2</b> <b>HYA3</b> <b>HYA4</b>	triggered and the value at which it is turned off (in engineering units).
<b>A1t.1</b> <b>A2t.1</b> <b>A3t.1</b> <b>A4t.1</b> Alarm Time t1	Defines the temporization time t1, in seconds, for the alarms. Defines the temporization time t1, in seconds, for the alarms time functions. The value 0 (zero) disables the function.  Refer to Table 4 for configuring this parameter timed functions. The value 0 (zero) disables the function.  Refer to Table 4 for configuring this parameter.
<b>A1t.2</b> <b>A2t.2</b> <b>A3t.2</b> <b>A4t.2</b>	Alarm Time t2. Defines the temporization time t2, in seconds, for the alarms time functions. The value 0 (zero) disables the function. Refer to Table 4 for configuring this parameter
<b>FLSh</b> Flash	Allows visual signalization of an alarm occurrence by flashing the indication of PV in the operation level. The user chooses which alarms are to be associated with this feature.

CYCLE OF SCALE

<b>TYPE</b> Type	INPUT TYPE: Selects the input signal type to be connected to the process variable input. Refer to Table 1 for the available options.
<b>FLtr</b> Filter	Digital Input Filter - Used to improve the stability of the measured signal (PV). Adjustable between 0 and 20. In 0 (zero) it means filter turned off and 20 means maximum filter. The higher the filter value, the slower is the response of the measured value.
<b>dPPO</b> Decimal Point	Selects the decimal point position to be viewed in both PV and SP.
<b>unit</b>	Unit. Temperature indication in °C or °F:
<b>root</b> Square Root	Square Root Function. Applies the quadratic function on the input signal, within the limits programmed in "SPLL" and "SPHL".  <b>YES</b> Enables the Function <b>no</b> Does not enable the Function  The indication assumes the lower limit value when the input signal is below 1 % of programmed span. Parameter available for lineal inputs only.
<b>OFFS</b> Offset	SENSOR OFFSET: Offset value to be added to the PV reading to compensate sensor error.  Default value: zero.
<b>Er.SP</b> Enable Remote SP	Enables remote SP.  <b>YES</b> Enables the Function <b>no</b> Does not enable the Function  This parameter is not displayed when the remote SP selection is defined by a Digital Input.
<b>r.SP</b> Remote SP type	Defines the signal type for the remote SP.  <b>0-20</b> current of 0-20 mA <b>4-20</b> current of 4-20 mA <b>0-5</b> voltage of 0-5 V <b>0-10</b> voltage of 0-10 V  Parameter displayed when remote SP is enabled.
<b>rSLL</b> Remote SP Low Limit	REMOTE SETPOINT LOW LIMIT: used in conjunction with the rSHL, scales the remote SP input defining the initial value in the remote SP indication range.  Parameter displayed when remote SP is enabled.



<b>rSHL</b> <i>Remote SP High Limit</i>	REMOTE SETPOINT HIGH LIMIT: defines the full scale indication of the Remote Setpoint. Parameter displayed when remote SP is enabled.
<b>SPLL</b> <i>Setpoint Low Limit</i>	Defines the SP lower limit of SP. For the linear analog input types available (0-20 mA, 4-20 mA, 0-50 mV, 0-5 V and 0-10 V), defines the minimum PV indication range, besides limiting the SP adjustment.
<b>SPHL</b> <i>Setpoint High Limit</i>	Defines the upper limit for adjustment of SP. For the linear analog input types available (0-20 mA, 4-20 mA, 0-50 mV, 0-5 V and 0-10 V), defines the maximum PV indication range, besides limiting the SP adjustment.
<b>rELL</b> <i>Retransmission Low Limit</i>	In association with the <b>rEHL</b> parameter, it defines the analog retransmission scale for PV or SP. The <b>rELL</b> represents the minimum scale value for the analog output  This parameter is displayed only if the analog retransmission is selected in the I/O 5 parameter (I/O level).
<b>rEHL</b> <i>Retransmission High Limit</i>	Defines the full scale value for the analog retransmission of PV or SP.  This parameter is displayed only when the analog retransmission is selected in the I/O 5 parameter (I/O level).
<b>IEou</b>	Percentage output value that will be transfer to MV when the SAFE output function is enabled. If <b>IEou</b> = 0, the SAFE output function is disabled and the outputs are turned off in the occurrence of a sensor fail.
<b>bAud</b> <i>Baud Rate</i>	Digital communication <i>Baud Rate</i> selection, in kbps: 1.2, 2.4, 4.8, 9.6, 19.2, 38.4, 57.6 and 115.2
<b>Prty</b> <i>Parity</i>	Parity of the serial communication.  <b>nonE</b> Without parity <b>Ewem</b> Even parity <b>Oddd</b> Odd parity
<b>Addr</b> <i>Address</i>	SLAVE ADDRESS SELECTION: Identifies the controller in the network. The possible address numbers are from 1 to 247.

CYCLE OF I/Os (INPUTS AND OUTPUTS)

<b>Io 1</b>	Function of the channel I/O 1: Selection of the function used in the channel I/O 1, according to the Table 2.
<b>Io 2</b>	Function of the channel I/O 2: Selection of the function used in the channel I/O 2, according to the Table 2.
<b>Io 3</b>	Function of the channel I/O 3: Selection of the function used in the channel I/O 3, according to the Table 2.
<b>Io 4</b>	Function of the channel I/O 4: Selection of the function used in the channel I/O 4, according to the Table 2.

<b>Io 5</b>	Function of the channel I/O 5: Selection of the function used in the channel I/O 5, according to the Table 2.
-------------	---

CALIBRATION CYCLE

All of the input and output types are calibrated in the factory. If a recalibration is required, this should be carried out by a experienced personnel. If this cycle is accidentally accessed, pass through all the parameters without pressing the  or  keys

<b>PASS</b> <i>Password</i>	Input of the Access Password.  This parameter is presented before the protected cycles. See item <b>Protection of Configuration</b> .
<b>InLC</b> <i>Input Low Calibration</i>	See section MAINTENANCE / Input Calibration. Enter the value corresponding to the low scale signal applied to the analog input.
<b>InHC</b> <i>Input High Calibration</i>	See section MAINTENANCE / Input Calibration. Enter the value corresponding to the full scale signal applied to the analog input.
<b>rSLC</b> <i>Remote SP Low Calibration</i>	See section: MAINTENANCE / Input Calibration Enter the value corresponding to the low scale signal applied to the remote SP input.
<b>rSHC</b> <i>Remote SP High Calibration</i>	See section: MAINTENANCE / Input Calibration. Enter the value corresponding to the full scale signal applied to the remote SP input.
<b>OutLC</b> <i>Output Low Calibration</i>	See section MAINTENANCE / Analog output Calibration. Enter the analog value as measured at the analog output.
<b>OutHC</b> <i>Output High Calibration</i>	See section MAINTENANCE / Analog output Calibration. Enter the analog value as measured at the analog output.
<b>rStr</b> <i>Restore</i>	Restores the factory calibration for all inputs and outputs, disregarding modifications carried out by the user.
<b>CJ</b>	Adjusts the of cold junction temperature value.
<b>HtYP</b> <i>Hardware Type</i>	Parameter that informs the controller about the hardware optionals installed. It should not be altered by the user, except when an accessory is introduced or removed.  0 – Basic model. Without optional items 1 – 485 2 – 3R 3 – 3R + 485 4 – DIO 5 – DIO + 485 8 – HBD 9 – HDB + 485  <b>Note:</b> The options 6 and 7 not are used.
<b>PASC</b>	Allows defining a new access password, always different from zero.
<b>Prot</b>	Sets up the Level of Protection. See Table 6.
<b>FrEQ</b>	Mains frequency. This parameter is important for proper noise filtering.



OPERATION CYCLE	TUNING CYCLE	PROGRAM CYCLE	ALARM CYCLE	CONFIGURATION CYCLE	I/O CYCLE	CALIBRATION CYCLE
PV and SP	<i>Rtun</i>	<i>PrLb</i>	<i>FuR1 - FuR4</i>	<i>tYPE</i>	<i>Io1</i>	<i>PRSS</i>
<i>CtrL</i>	<i>Pb</i>	<i>Pr n</i>	<i>bLR1 - bLR4</i>	<i>FLtr</i>	<i>Io2</i>	<i>InLC</i>
PV and MV	<i>lr</i>	<i>PtoL</i>	<i>HYR1 - HYR4</i>	<i>dPPo</i>	<i>Io3</i>	<i>InHC</i>
<i>EPr</i>	<i>dt</i>	<i>PSP0 - PSP9</i>	<i>Rlt1</i>	<i>unlt</i>	<i>Io4</i>	<i>rSLC</i>
<i>PSEG</i>	<i>Ct</i>	<i>Pt1 - Pt9</i>	<i>Rlt2</i>	<i>root</i>	<i>Io5</i>	<i>rSHC</i>
<i>tSEG</i>	<i>HYSt</i>	<i>PE1 - PE9</i>	<i>R2t1</i>	<i>oFFS</i>		<i>DUtC</i>
<i>run</i>	<i>ACt</i>	<i>LP</i>	<i>R2t2</i>	<i>ErSP</i>		<i>DUHC</i>
	<i>Lbdt</i>		<i>FLSh</i>	<i>rSP</i>		<i>rStt</i>
	<i>bIAS</i>			<i>rSLL</i>		<i>CJ</i>
	<i>ouLL</i>			<i>rSHL</i>		<i>HEYP</i>
	<i>ouHL</i>			<i>SPLL</i>		<i>PRSC</i>
	<i>SFSt</i>			<i>SPHL</i>		<i>Prot</i>
	<i>SPR1 - SPR4</i>			<i>IEou</i>		<i>FrEQ</i>
				<i>rELL</i>		
				<i>rEHL</i>		
				<i>bAud</i>		
				<i>Prty</i>		
				<i>Addr</i>		

Table 6 – All the Controller's Parameters

## PROTECTION OF CONFIGURATION

The controller provides means for protecting the parameters configurations, not allowing modifications to the parameters values, avoiding tampering or improper manipulation.

The parameter **Protection (Prot)**, in the Calibration level, determines the protection strategy, limiting the access to particular levels, as shown by the table below.

Protection level	Protected cycles
1	Only the Calibration level is protected.
2	I/Os and Calibration levels.
3	Tuning, I/Os and Calibration levels.
4	Alarm, Tuning, I/Os and Calibration levels.
5	Programs, Alarm, Tuning, I/Os and Calibration levels.
6	Tuning, Programs, Alarm, Input, I/Os and Calibration levels.
7	Operation (except SP), Tuning, Programs, Alarm, input, I/Os and Calibration levels.
8	Operation, Tuning, Programs, Alarm, Input, I/Os and Calibration levels.

Table 7 – Levels of Protection for the Configuration

### Access Password:

The protected levels, when accessed, request the user to provide the **Access Password** for granting permission to change the configuration of the parameters on these cycles.

The prompt **PRSS** precedes the parameters on the protected levels. If no password is entered, the parameters of the protected cycles can only be visualized.

The Access Code is defined by the user in the parameter **Password Change (PRSC)**, present in the Calibration level. The factory default for the password code is 1111.

### Protection of the access code

The protection system built into the controller blocks for 10 minutes the access to protected parameters after 5 consecutive frustrated attempts of guessing the correct password.

### Master Password

The Master Password is intended for allowing the user to define a new password in the event of it being forgotten. The Master Password doesn't grant access to all parameters, only to the Password Change parameter (**PRSC**). After defining the new password, the protected parameters may be accessed (and modified) using this new password.

The master password is made up by the last three digits of the serial number of the controller **added** to the number 9000.

As an example, for the equipment with serial number 07154321, the master password is 9321.

## PROGRAMS OF RAMP AND SOAK

This feature allows the creation of Ramp and Soak Setpoint Profiles (Programs). Up to 20 different profiles with 9 segments each can be programmed. Longer profiles of up to 180 segments can be created by linking 2 or more profiles together.

The figure below displays a profile model:

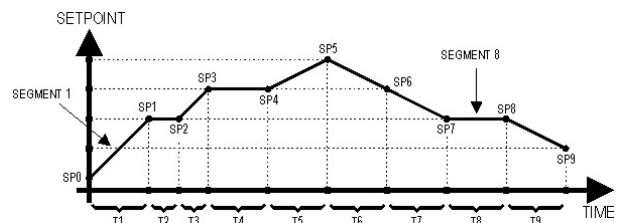

Figure 8 - Example of a Ramp and Roak.

Once a profile is defined and selected for execution (parameter **EPr** in the operating level), the controller starts to generate the SP profile automatically in accordance with the elaborated program.

To execute a profile with fewer segments just program 0 (zero) for the time intervals that follow the last segment to be executed.

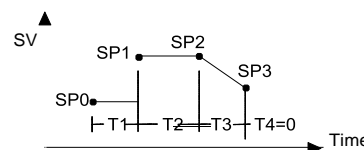

Figure 9 - Program example with few segments

The program tolerance defines the maximum deviation between PV and SP for the execution of the profile. If this deviation is exceeded, the program will be halted until the deviation falls to within the tolerance band.

Programming 0 (zero) in the "**Ptol**" parameter disables the program tolerance and the profile execution will continue regardless of the PV value (time priority as opposed to SP priority).

### LINK OF PROGRAMS

It is possible to create a more complex program, with up to 180 segments, joining the 20 programs. This way, at the end of a program execution the controller immediately starts to run the next one, as indicated in the "**LP**".

To force the controller to run a given program or many programs continuously, it is only necessary to link a program to itself or the last program to the first.

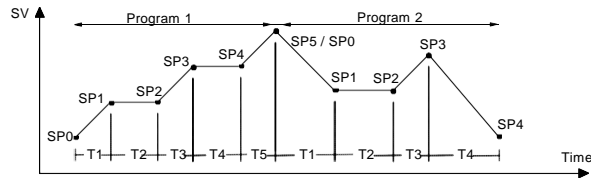

Figure 10 - Example of interlinked programs

### EVENT ALARM

The Event Alarm function associates the alarms to specific segments of a program. The information of which alarms are to be activated or deactivated is given in parameters "**PE 1**" to "**PE 9**". Press the and keys until the desired alarm numbers are displayed.

The Event Alarm requires that the Alarm function be configured as "**r5**".

#### Notes:

1. If **Ptol** is different than zero, the controller will wait for the PV to reach the first program set point SP0 in order to start the program execution. Otherwise, it will start promptly.
2. Should any power failure occur, the controller resumes the program execution at the beginning of the segment that was interrupted.

### DETERMINATION OF PID PARAMETERS

The determination (or tuning) of the PID control parameters in the controller can be carried out in an automatic way and auto-adaptive mode. The **automatic tuning** is always initiated under request of the operator, while the **auto-adaptive tuning** is initiated by the controller itself whenever the control performance becomes poor.

**Automatic tuning:** In the beginning of the **automatic tuning** the controller has the same behavior of an ON/OFF controller, applying minimum and maximum performance to the process. Along the tuning process the controller's performance is refined until its conclusion, already under optimized PID control. It begins immediately after the selection of the options FAST, FULL, RSLF or TGHT, defined by the operator in the parameter ATUN.

**Auto-adaptive tuning:** Is initiated by the controller whenever the control performance is worse than the one found after the previous tuning. In order to activate the performance supervision and **auto-adaptive tuning**, the parameter ATUN must be adjusted for SELF, RSLF or TGHT. The controller's behavior during the **auto-adaptive tuning** will depend on the worsening of the present performance. If the maladjustment is small, the tuning is practically imperceptible for the user. If the maladjustment is big, the **auto-adaptive tuning** is similar to the method of **automatic tuning**, applying minimum and maximum performance to the process in ON/OFF control.

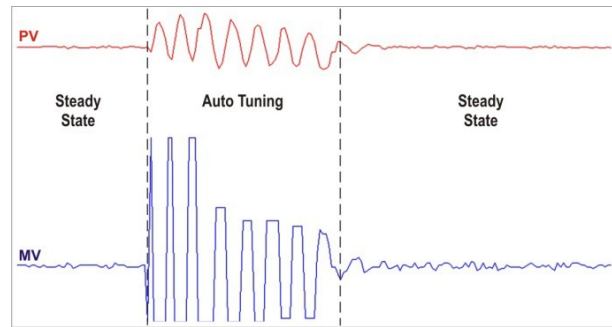

Figure 11 – Example of auto tuning

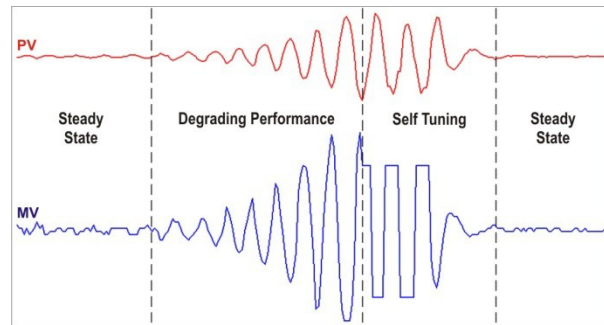

Figure 12 - Example of auto-adaptive tuning

The operator may select, through the ATUN parameter, the desired tuning type among the following options:

- OFF: The controller does not carry through **automatic tuning** or **auto-adaptive tuning**. The PID parameters will **not** be automatically determined **nor** optimized by the controller.
- FAST: The controller will accomplish the process of **automatic tuning** one single time, returning to the OFF mode after finishing. The tuning in this mode is completed in less time, but not as precise as in the FULL mode.
- FULL: The same as the FAST mode, but the tuning is more precise and slower, resulting in better performance of the P.I.D. control.
- SELF: The performance of the process is monitored and the **auto-adaptive tuning** is automatically initiated by the controller whenever the performance becomes poorer.

After a tuning cycle, the controller starts collecting data from the process for determining the performance benchmark that will allow evaluate the need for future tunings. This phase is proportional to the process response time and is signaled by the flashing TUNE indication on the display. It is recommended not to turn the controller off neither change the SP during this learning period.

- rSLF: Accomplishes the **automatic tuning** and returns into the SELF mode. Typically used to force an immediate **automatic tuning** of a controller that was operating in the SELF mode, returning to this mode at the end.
- TGHT: Similar to the SELF mode, but in addition to the **auto-adaptive tuning** it also executes the **automatic tuning** whenever the controller is set in RUN=YES or when the controller is turned on.

Whenever the parameter ATUN is altered by the operator into a value different from OFF, an automatic tuning is immediately initiated by the controller (if the controller is not in RUN=YES, the tuning will begin when it passes into this condition). The accomplishment of this automatic tuning is essential for the correct operation of the auto-adaptive tuning.

The methods of **automatic tuning** and **auto-adaptative tuning** are appropriate for most of the industrial processes. However, there may be processes or even specific situations where the methods are not capable to determine the controller's parameters in a satisfactory way, resulting in undesired oscillations or even taking the process to extreme conditions. The oscillations themselves imposed by the tuning methods may be intolerable for certain processes. These possible undesirable effects must be considered before beginning the controller's use, and preventive measures must be adopted in order to assure the integrity of the process and users.

The "TUNE" signaling device will stay on during the tuning process.

In the case of PWM or pulse output, the quality of tuning will also depend on the cycle time adjusted previously by the user.

If the tuning does not result in a satisfactory control, refer to **Table 8** for guidelines on how to correct the behavior of the process.

PARAMETER	VERIFIED PROBLEM	SOLUTION
Proportional Band	Slow answer	Decrease
	Great oscillation	Increase
Rate of Integration	Slow answer	Increase
	Great oscillation	Decrease
Derivative Time	Slow answer or instability	Decrease
	Great oscillation	Increase

**Table 8** - Guidance for manual adjustment of the PID parameters

## MAINTENANCE

### PROBLEMS WITH THE CONTROLLER

Connection errors and inadequate programming are the most common errors found during the controller operation. A final revision may avoid loss of time and damages.

The controller displays some messages to help the user identify problems.

MESSAGE	DESCRIPTION OF THE PROBLEM
----	Open input. No sensor or signal.
<b>Err 1</b> <b>Err 6</b>	Connection and/or configuration errors. Check the wiring and the configuration.

Other error messages may indicate hardware problems requiring maintenance service. When contacting the manufacturer, inform the instrument serial number, obtained by pressing the key **[F1]** for more than 3 seconds.

### CALIBRATION OF THE INPUT

All inputs are factory calibrated and recalibration should only be done by qualified personnel. If you are not familiar with these procedures do not attempt to calibrate this instrument.

The calibration steps are:

- Configure the type of input to be calibrated.
- Configure the lower and upper limits of indication for the maximum span of the selected input type.
- At the input terminals inject a signal corresponding to a known indication value a little above the lower display limit.
- Access the parameter "**InLc**". With the keys **[▲]** and **[▼]** adjust the display reading such as to match the applied signal. Then press the **[F]** key.
- Inject a signal that corresponds to a value a little lower than the upper limit of indication.
- Access the parameter "**InLc**". With the keys **[▲]** and **[▼]** adjust the display reading such as to match the applied signal. Then press the **[F]** key.

**Note:** When checking the controller calibration with a Pt100 simulator, pay attention to the simulator minimum excitation current requirement, which may not be compatible with the 0.170 mA excitation current provided by the controller.

### ANALOG OUTPUT CALIBRATION

- Configure I/O 5 for the current output to be calibrated, be it control or retransmission.
- In the screen "**ctrl**", program manual mode (**man**).
- Connect a current meter to the analog output.
- Enter the calibration cycle with the correct password.
- Select the screen "**ouLc**". Press the keys **[▲]** and **[▼]** for the controller to recognize the calibration process of the current output.
- Read the current indicated on the current meter and adjust the parameter "**ouLc**" to indicate this current value (use the keys **[▲]** and **[▼]**).
- Select the screen "**ouHc**". Press the keys **[▲]** and **[▼]** for the controller to recognize the calibration process of the current output.
- Read the current indicated on the current meter and adjust the parameter "**ouHc**" to indicate this current value.
- Press the key **[F]** in order to confirm the calibration procedure and return to the operating level.

### SERIAL COMMUNICATION

The controller can be supplied with an asynchronous RS-485 digital communication interface for master-slave connection to a host computer (master).

The controller works as a slave only and all commands are started by the computer which sends a request to the slave address. The addressed unit sends back the requested reply.

Broadcast commands (addressed to all indicator units in a multidrop network) are accepted but no reply is sent back in this case.

### CHARACTERISTICS

- Signals compatible with RS-485 standard. MODBUS (RTU) Protocol. Two wire connection between 1 master and up to 31 (addressing up to 247 possible) instruments in bus topology. The communication signals are electrically insulated from the rest of the device;
- Maximum connection distance: 1000 meters.
- Time of disconnection for the controller: Maximum 2 ms after last byte.
- Selectable speed; 8 data bits; 1 stop bit; selectable parity (no parity, pair or odd);
- Time at the beginning of response transmission: maximum 100 ms after receiving the command.

The RS-485 signals are:

D1	D	D +	B	Bi-directional data line.	Terminal 16
D0	$\bar{D}$	D -	A	Bi-directional inverted data line.	Terminal 17
C				Optional connection that improves the performance of the communication.	Terminal 18
GND					

### CONFIGURATION OF PARAMETERS FOR SERIAL COMMUNICATION

Two parameters must be configured for using the serial type:

**bAud:** Communication speed.

**Prty:** Parity of the communication.

**Addr:** Communication address for the controller.

## REDUCED REGISTERS TABLE FOR SERIAL COMMUNICATION

### Communication Protocol

The MOSBUS RTU slave is implemented. All configurable parameters can be accessed for reading or writing through the communication port. Broadcast commands are supported as well (address 0).

The available Modbus commands are:

- |                            |                               |
|----------------------------|-------------------------------|
| 03 - Read Holding Register | 06 - Preset Single Register   |
| 05 - Force Single Coil     | 16 - Preset Multiple Register |

### Holding Registers Table

Follows a description of the usual communication registers. For full documentation download the Registers Table for Serial Communication in the N1200 section of our web site – [www.novusautomation.com](http://www.novusautomation.com).

All registers are 16 bit signed integers.

Address	Parameter	Register Description
0000	Active SP	Read: Active control SP (main SP, from ramp and soak or from remote SP). Write: to main SP. Range: from <b>spil</b> to <b>spkl</b> .
0001	PV	Read: Process Variable. Write: Not allowed. Range: Minimum value is the one configured in <b>SPLL</b> and the maximum value is the one configured in <b>SPhL</b> . Decimal point position depends on <b>dPPo</b> value. In case of temperature reading, the value read is always multiplied by 10, independently of <b>dPPo</b> value.
0002	MV	Read: Output Power in automatic or manual mode. Write: Not allowed. See address 28. Range: 0 to 1000 (0.0 to 100.0 %).

## SPECIFICATIONS

- DIMENSIONS:**..... 48 x 48 x 110 mm (1 / 16 DIN)  
..... Approximate Weight: 150 g
- CUTOUT IN THE PANEL:** .....45.5 x 45.5 mm (+0.5 -0.0 mm)
- POWER SUPPLY**.....100 a 240 Vac/dc ( $\pm 10\%$ ), 50 / 60 Hz  
Optionally:..... 24 Vac/dc  $\pm 10\%$   
Maximum consumption: ..... 9 VA
- ENVIRONMENTAL CONDITIONS:**  
Operation Temperature: ..... 5 to 50 °C  
Relative Humidity: .....80 % max. @ 30 °C  
For temperatures above 30 °C, reduce 3 % for each °C  
Internal Use; Category of installation II, Degree of pollution 2;  
altitude < 2000 m
- INPUT**.....T/C, Pt100, voltage and current (according to Table 1)  
**Internal Resolution:** ..... 32767 levels (15 bits)  
**Resolution of Display:** .... 12000 levels (from - 1999 up to 9999)  
**Rate of input reading:** .....up to 55 per second  
**Precision:** Thermocouples J, K, T, E: 0.25 % of the *span*  $\pm 1$  °C  
.....Thermocouples N, R, S, B: 0.25 % of the *span*  $\pm 3$  °C  
.....Pt100: 0.2 % of the *span*  
.....4-20 mA, 0-50 mV, 0-5 Vdc: 0.2 % of the *span*  
**Input Impedance:** 0-50 mV, Pt100 and Thermocouples: >10 M $\Omega$   
..... 0-5 V: >1 M $\Omega$   
.....4-20 mA: 15  $\Omega$  (+2 Vdc @ 20 mA)  
**Measurement of Pt100:** ..... Three wire type, ( $\alpha=0.00385$ )  
with compensation for cable length, excitation current of 0.170 mA.  
All input and output types are factory-calibrated. Thermocouples according to standard NBR 12771 / 99, RTD's NBR 13773 / 97;
- ANALOGICAL OUTPUT (I/O5):** .....0-20 mA or 4-20 mA, 550 $\Omega$  max.  
31000 levels, insulated, for control or retransmission of PV and SP
- CONTROL OUTPUT:**  
2 Relays SPST-NA (I/O1 and I/O2): 1.5 A / 240 Vac, general use  
.....1 Relay SPDT (I/O3): 3 A / 250 Vac, general use  
.....Voltage pulse for SSR (I/O5): 10 V max. / 20 mA  
..... Voltage pulse for SSR (I/O3 and I/O4): 5 V max. / 20 mA
- ELECTROMAGNETIC COMPATIBILITY:**..... EN 61326-1:1997 and EN 61326-1 / A1:1998
- SAFETY:** ..... EN61010-1:1993 and EN61010-1 / A2:1995
- USB INTERFACE 2.0, CDC CLASS (VIRTUAL COMMUNICATIONS PORT), MODBUS RTU PROTOCOL.**
- SPECIFIC CONNECTIONS FOR TYPE FORK TERMINALS OF 6.3 MM;**
- FRONT PANEL:** IP65, POLYCARBONATE - UL94 V-2;  
**CASE:** IP30, ABS+PC UL94 V-0;  
**STARTS UP OPERATION AFTER 3 SECONDS CONNECTED TO THE POWER SUPPLY;**  
**CERTIFICATIONS:** .....CE / UL (FILE: 300526)

## IDENTIFICATION

N1200 -	3R -	485 -	24V
A	B	C	D

A: Controller Model:

**N1200**;

B: Optional I/Os:

**Blank** (basic version, without I/O3 nor I/O4);

**3R** (SPDT Relay in I/O3);

**DIO** (Digital I/Os in I/O3 and I/O4);

**HBD** (Burnt-Out Resistance detection);

C: Digital Communication:

**Blank** (basic version, without serial communication);

**485** (RS485, Modbus protocol)

D: Power Supply:

**Blank** (basic version, 100 to 240 Vac/dc input);

**24V** (24 Vac/dc input voltage);